



# IVR 230



 Valvola a sfera a passaggio totale, 2 vie, motorizzabile, con flangia ISO 5211, attacchi F/F

 2-way full bore ball valve, motorisable, with ISO 5211 flange, threaded ends F/F

 2-Wege-Kugelhahn mit vollem Durchgang, motorisierbar, mit Flansch ISO 5211, IG/IG

 Vanne à boisseau sphérique à passage intégral à 2 voies, motorisable, avec la bride ISO 5211, fixations F/F

Полнопроходной шаровой кран для привода, с двухходовым клапаном, фланец ISO 5211, соединения В/В.

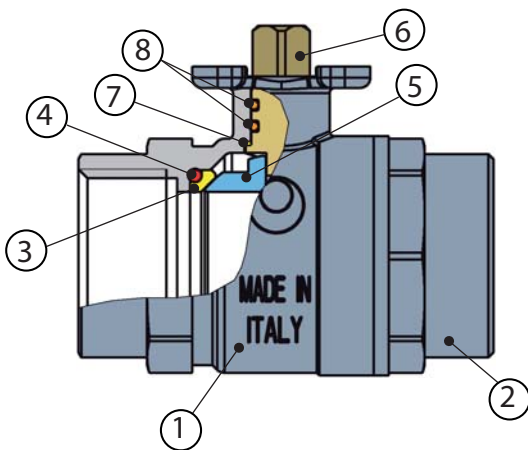

N	DENOMINAZIONE PART NAME	MATERIALE MATERIAL	TRATTAMENTO TREATMENT
1	Corpo - Body	Ottone - Brass CW617DW - UNI EN 2165/98	Nichelato - Nickel plated
2	Manicotto - Body end	Ottone - Brass CW617DW - UNI EN 2165/98	Nichelato - Nickel plated
3	Seggio - Seat	PTFE G200 - PTFE G200	
4	O-Ring - O-Ring	EPDM - EPDM	
5	Sfera - Ball	Ottone - Brass CW 617N - UNI EN 12165/98	Cromata - Chrome plated
6	Asta - Stem	Ottone - Brass CW614DW - UNI EN 12164/98	
7	Rodella - Washer	PTFE G200 - PTFE G200	
8	O-Ring - O-Ring	EPDM Perox - EPDM Perox	

PRESSIONE / TEMPERATURA - PRESSURE / TEMPERATURE

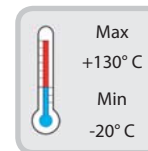
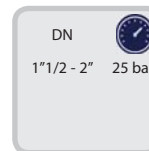
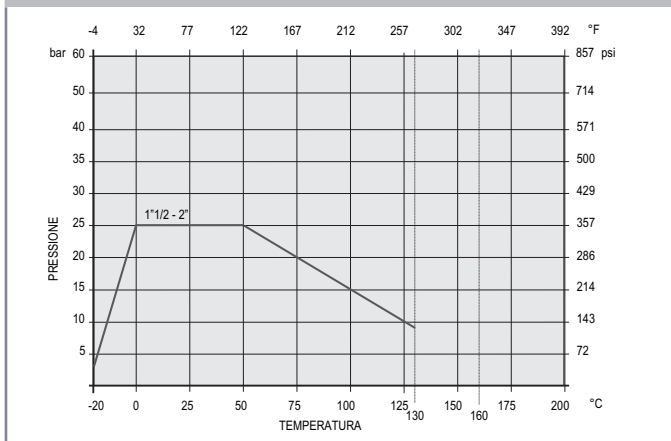

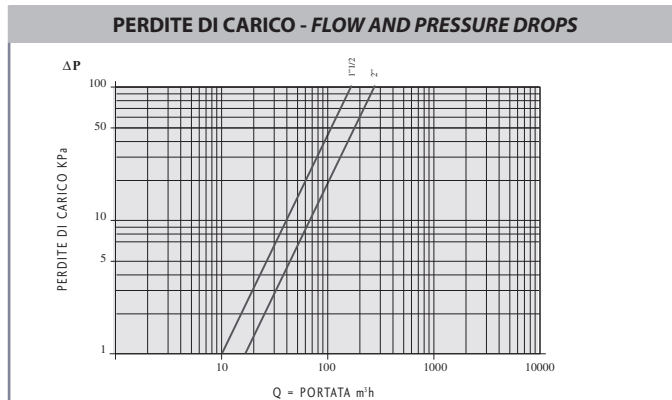

Misura - Size	KV
1" 1/2 - 40	170
2" - 50	265

## DIMENSIONI - DIMENSIONS (mm)

Size	Ø	F	L	S	S1	S2	S3	S4	S5	H	h	Q	ISO
1"1/2	40	22		101						51	11	11	F04
2"	50	26		121						58	11	11	F04

